

**KOBELCO**

SK260LC-10/SK260NLC-10

**SK260<sub>LC</sub> SK260<sub>NLC</sub>**



**We Save You Fuel**  
Achieving a Low-Carbon Society

# Power Meets Efficiency



**SK260<sub>LC</sub> SK260<sub>NLC</sub>**



**10%**  
Higher fuel efficiency  
means  
"Efficiency"

Increase in  
productivity  
means  
"Power"

Compared to S-mode on the SK260LC-9

To urban centers, and to mines around the world. Kobelco's all-out innovation brings you durable earth-friendly construction machinery that's equal to any task, at sites all over the planet. Increased power and even greater fuel economy bring higher efficiency to any project. Kobelco SK260LC machines are also more durable than ever, able to withstand the rigors of the toughest job sites. It all adds up to new levels of value that are a step ahead of the times. Also, this machine conforms to Stage IV Exhaust Emission Standards, thanks to its significantly reduced NOx\* emissions. While focusing on the global environment of the future, Kobelco offers next-generation productivity to meet the need for lower life cycle costs and exceed the expectations of customers the world over.

\* NOx: Nitrogen Oxide



# Evolution Continues, with Improved Fuel Efficiency

## Hydraulic System: Revolutionary Technology Saves Fuel

### Arm Interflow System NEW

When lowering the boom, this system uses the downward force generated by the boom's weight to push fluid to the shovel arm. This greatly reduces the need to apply power from outside the system.

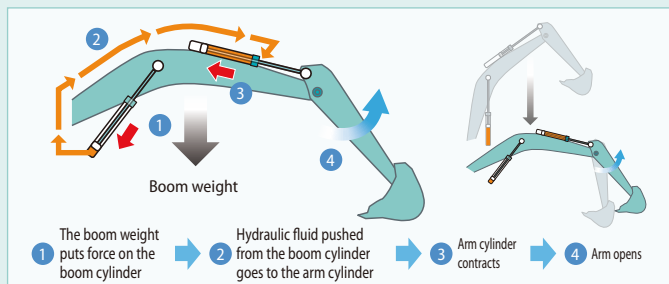

### Hydraulic circuit reduces energy loss

We have made every effort to enhance fuel efficiency by minimizing hydraulic pressure resistance, improving the hydraulic line layout to control friction resistance loss and minimizing valve resistance.

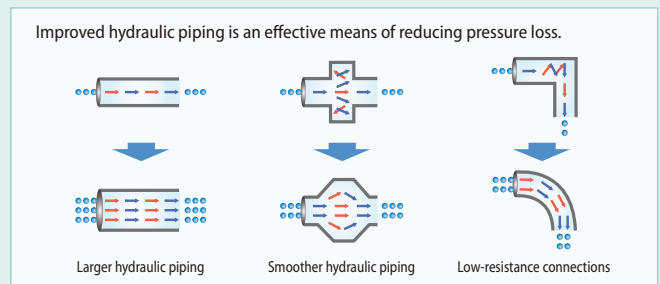

## In Pursuit of Improved Fuel Efficiency

### Operation Mode

Fuel consumption is lower in ECO-mode/S-mode in comparison with the previous model (Generation 9).

#### ■ Compared to previous models



- E** ECO-mode  
... About **9%** improvement
- S** S-mode  
... About **10%** improvement

**Always and Forever. Yesterday, Today, and Tomorrow. We're Obsessed with Fuel Efficiency.**

Over the past 10 years, KOBELCO has achieved an average fuel consumption reduction of 36% across its fleet. We vow to lead the industry in improving fuel efficiency.

#### ■ Compared to SK260LC-6 model (2006)

- E** ECO-mode (SK260LC-10)  
... About **36%** improvement

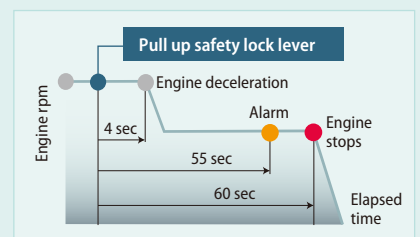

### AIS (Auto Idle Stop)

If the boarding/disembarking lever is left up, the engine will stop automatically. This eliminates wasteful idling during standby, saving fuel and reducing CO<sub>2</sub> emissions as well.



**10%**  
Higher fuel efficiency  
means  
"Efficiency"

The new arm interflow system more efficiently controls hydraulic fluid flow, and significant reduction of in-line resistance and pressure loss boosts fuel efficiency by about 10%\*1. The engine, already well-known for its environmental performance has a new SCR\*2 system, and its reduced NOx emissions means the engine now meets Stage IV Standards.

\*1 Compared to S-mode on the SK260LC-9  
\*2 SCR: Selective Catalytic Reduction

**Engine Meets Stage IV Standards**

**Reduces Fuel Consumption and Minimizes Exhaust Emissions**

Hino engines are renowned for fuel efficiency and environmental performance, and Kobelco has tuned these powerplants especially for construction machinery. The pressure within the common rail fuel injection system, the VG turbo, and the exhaust gas after-treatment system reduce exhaust PM\*3 while the large-capacity EGR cooler sharply reduces the formation of NOx gases.

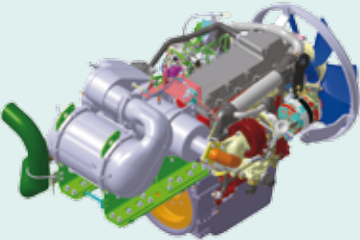

\*3 PM: Particulate Matter

**VG Turbo Reduces PM**

The variable-geometry turbocharger adjusts air intake to maximize combustion efficiency. At low engine speeds the nozzles are closed, the turbo speed increased and air intake is boosted. This helps lower fuel consumption.

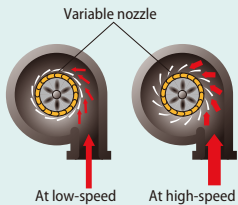

**SCR System with DEF/AdBlue**

**NEW**

The engine exhaust system has an SCR system that converts NOx emissions into harmless nitrogen and water. Combining this with a post-exhaust gas treatment system that captures and disposes of PM, the SK260LC has a much cleaner exhaust that meets Stage IV exhaust emission standards.

■ **NOx reduction rate**  
(Compared to previous models)

About **80%** decrease

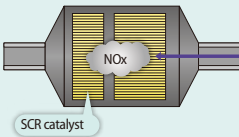

**EGR Cooler Reduces NOx**

Cooled exhaust gases from the EGR cooler are mixed with fresh air in the intake. The recirculated air lowers the combustion temperature which reduces NOx.

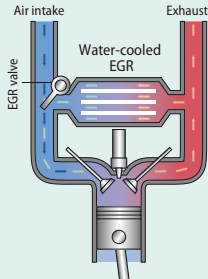

# More Power and Higher Efficiency

The highly efficient hydraulic system minimizes fuel consumption while maximizing power. With nimble movement and ample digging power, this excavator promises to improve your job productivity.

Improved fuel efficiency contributes to high performance

## Superior Digging Volume

This excavator offers dynamic digging force even as it minimizes fuel consumption rates, achieving class-leading work volume. H-mode with an increased torque setting delivers about 5% greater digging volume.

■ Digging volume/hour  
(Compared to H-mode on previous models)



■ Max. Bucket Digging Force

Normal: 170kN  
With power boost: 187kN

■ Max. Arm Crowding Force

Normal: 122kN  
With power boost: 134kN

\*Values are for HD arm (2.98m)

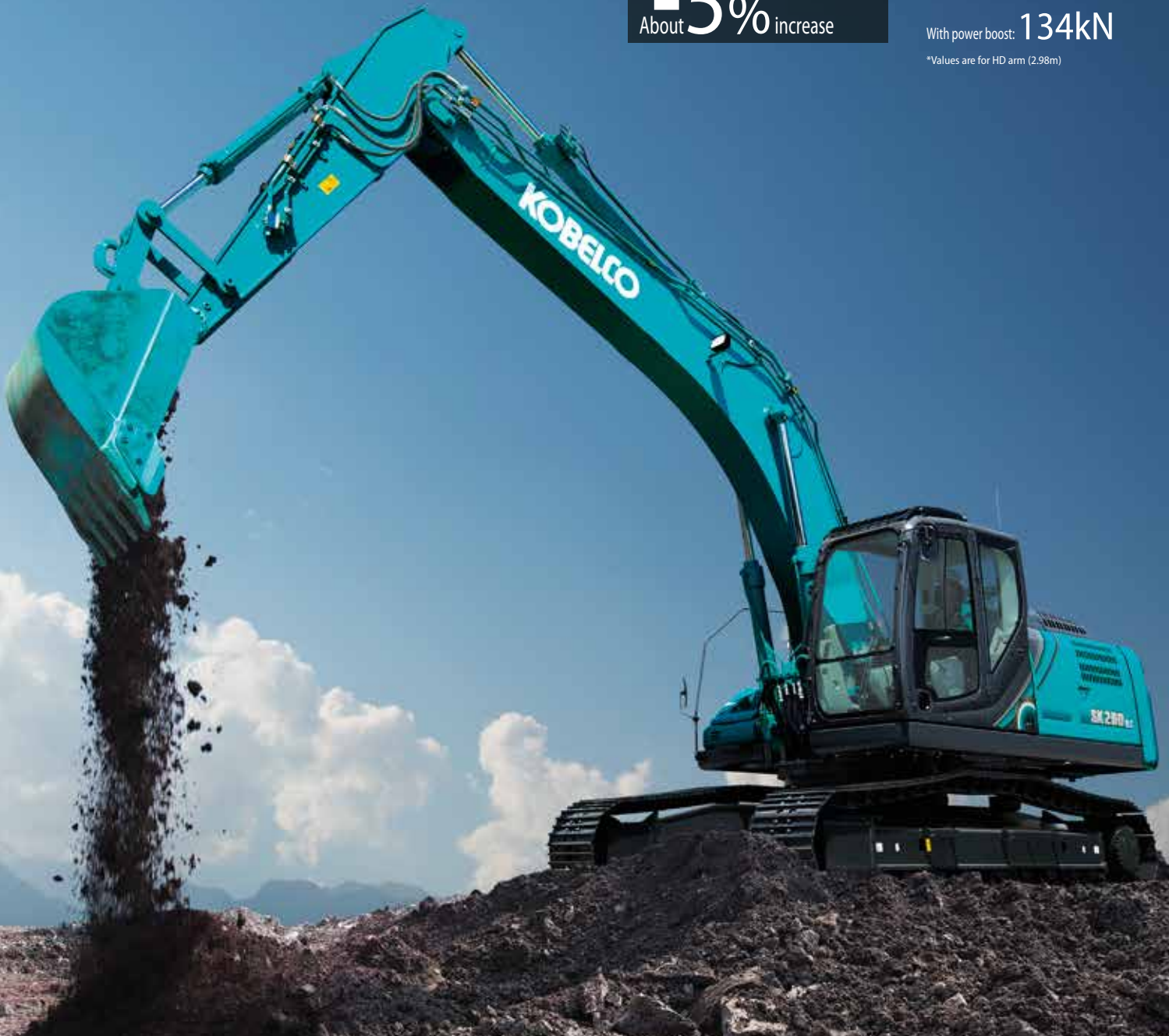

## Get More Done Faster with Superior Operability

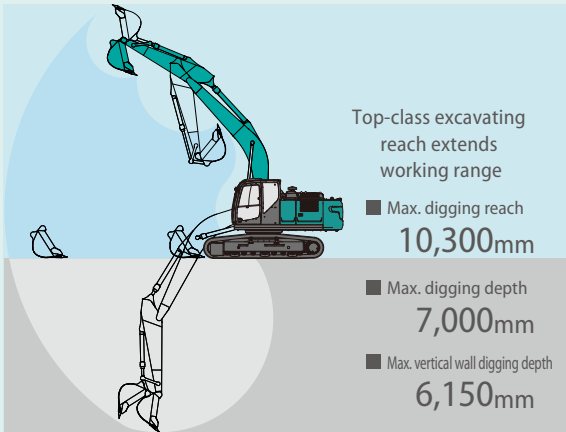

### Piping for Quick Hitch (optional)



A quick hitch hydraulic line, which speeds up attachment changes, is available as an option.

### A Light Touch on the Lever Means Smoother, Less Tiring Work **NEW**



It takes 25% less effort to work the operation lever, which reduces fatigue over long working hours or continued operations.

### Top Class Traveling Force

Powerful traveling force and pulling force deliver plenty of speed when climbing slopes or negotiating bad roads, and the agility to change direction swiftly and smoothly.



■ Drawbar Pulling Force: **245kN**

## Operator-friendly Features Include Controls that Are Easy to See, Easy to Use



### Multi-Display in Color

Brilliant colors and graphic displays are easy to recognize on the LCD multi-display in the console. The display shows fuel consumption, maintenance intervals, and more.

- 1 Analog gauge provides an intuitive reading of fuel level and engine water temperature
- 2 Green indicator light shows low fuel consumption during operation
- 3 PM accumulation display (left)/AdBlue level gauge (right)
- 4 Fuel consumption/Switch indicator for rear camera images
- 5 Digging mode switch
- 6 Monitor display switch

### One-Touch Attachment Mode Switch

A simple flick of a switch converts the hydraulic circuit and flow amount to match attachment changes. Icons help the operator to confirm the proper configuration at a glance.



PM accumulation/AdBlue accumulation display



Fuel consumption



Maintenance

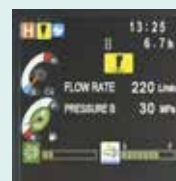

Breaker mode

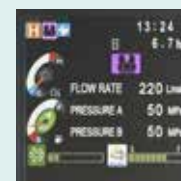

Nibbler mode



Rearview monitoring

# Increased Power, with Enhanced Durability to Maintain the Machine's Value

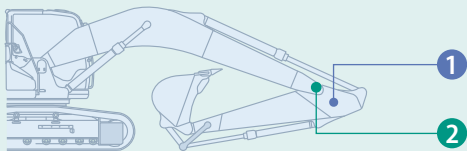

## Built to Operate in Tough Working Environments

The attachment has been reinforced to handle a higher work volume, with greater power and excellent durability that can withstand demanding work conditions.

### 1 Enlarged Reinforcement of the Arm Foot

NEW

HD: Base plate thickness has been increased 1.3 times.

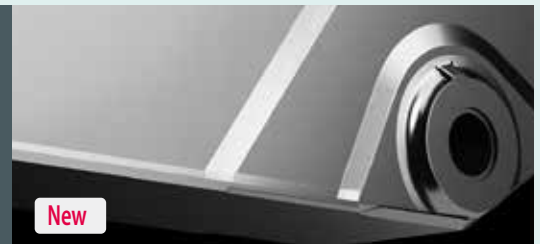
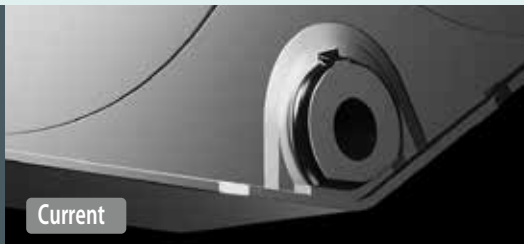

### 2 Modified Foot Boss Shape

NEW

The arm foot boss shape has been modified and improved to distribute stress, delivering 2.6 times more strength for tasks like digging next to a wall.

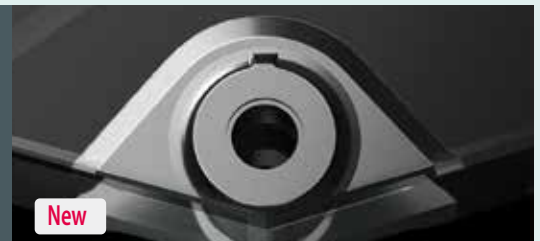
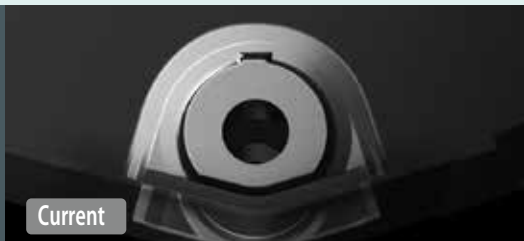



Increase in productivity means "Power"

Structural design increases strength, while eliminating hydraulic problems. Enhanced durability takes productivity to a new level.



### Improved Filtration System Reliability

Clean, contaminant-free fuel and hydraulic fluid are essential to stable performance. The improved filtration systems reduce the risk of mechanical trouble and enhance longevity and durability.

#### Hydraulic Fluid Filter **NEW**

Recognized as the best in the industry, our super-fine filter separates out even the smallest particles. New cover prevents contamination when changing filters.



#### Hydraulic Fluid Filter Clog Detector **NEW**

Pressure sensors at the inlet and outlet of the hydraulic fluid filter monitor differences in pressure to determine the degree of clogging. If the difference in pressure exceeds a predetermined level, a warning appears on the multi-display, so any contamination can be removed from the filter before it reaches the hydraulic fluid reservoir.

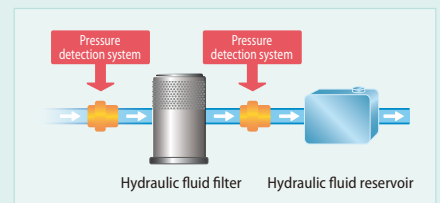

#### Double-Element Air Cleaner

The large-capacity element features a double-filter structure that keeps the engine running clean even in industrial environments.



#### Fuel Filter **NEW**

The pre-filter, with built-in water separator maximizes filtering performance.

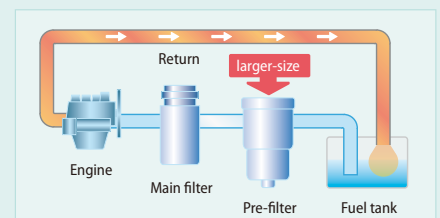

# Comfortable Cab Is Now Safer than Ever

A work environment that is quieter and more comfortable. A cab that puts the operator first is key to improved safety.



## Comfort

### Super-Airtight Cab



The high level of air-tightness keeps dust out of the cab.

### Quiet Inside

The high level of air-tightness ensures a quiet, comfortable cabin interior.

### Low Vibration

Coil springs absorb small vibrations, and high suspension mounts filled with silicone oil reduce heavy vibration. The long stroke achieved by this system provides excellent protection from vibration.

Twice the stroke of a conventional mount

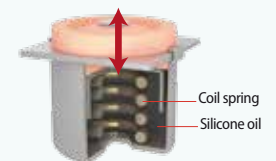

### Broad View Liberates the Operator

The front window features one large piece of glass without a center pillar on the right side for a wide, unobstructed view.

## Air Conditioner Register NEW behind the Seat



The large air-conditioner has registers on the back pillars that blow from behind and to the right and left of the operator's seat. They can be adjusted to put a direct flow of cool/warm air on the operator, which means a more comfortable operating environment.

## More Comfortable Seat Means Higher Productivity



Seat suspension absorbs vibration



Seat recliner can be pushed back flat



Double slides allow adjustment for optimum comfort



## Large Cab Is Easy to Get in and out of

The expanded cab provides plenty of room for a large door, more headroom and smoother entry and exit.

## Interior Equipment Adds to Comfort and Convenience



Automatic AM/FM radio



USB pin/24V power outlet



Spacious storage tray



Large cup holder

## Safety

### ROPS Cab

ROPS (Roll-Over-Protective Structure)-compliant cab clears ISO standards (ISO-12117-2: 2008) and ensures greater safety for the operator should the machine tip over.



TOP Guard is fitted as standard.



### Expanded Field of View for Greater Safety



Rearview mirrors left and right/right-hand bottom clearance mirror

Greater safety assured by rearview mirrors on left and right, and a third mirror mounted at lower right.



Rear view

Rear view shows the area directly behind the cab.

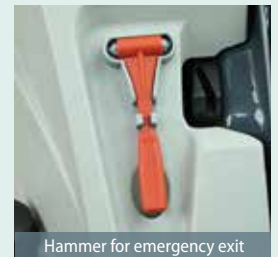

Hammer for emergency exit

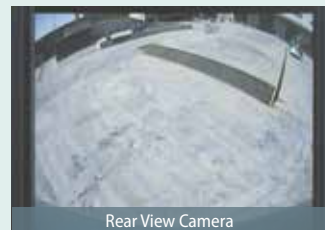

Rear View Camera

A rear view camera is installed as standard to simplify checking for safety behind the machine. The picture appears on the color monitor.

# KOMEXS

## KOBELCO MONITORING EXCAVATOR SYSTEM



### Remote Monitoring for Peace of Mind

KOMEXS (Kobelco Monitoring Excavator System) uses satellite communication and internet to relay data, and therefore can be deployed in areas where other forms of communication are difficult. When a hydraulic excavator is fitted with this system, data on the machine's operation, such as operating hours, location, fuel consumption, and maintenance status can be obtained remotely.

### Direct Access to Operational Status

#### Location Data

Accurate location data can be obtained even from sites where communications are difficult.

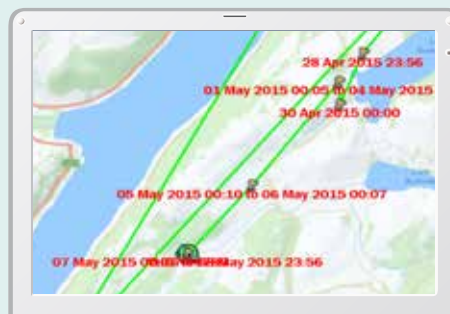

Work data

Period	11 Apr, 2015	10 May, 2015	Search
Type of Operation	Working Hrs	Ratio	
Total Working Hrs	169 Hrs	100 %	
Digging Hrs	72.2 Hrs	43 %	
Traveling Hrs	18.3 Hrs	11 %	
Idle Hrs	15.9 Hrs	9 %	
Opt Alt Hrs	62.5 Hrs	37 %	
Crane Mode Hrs	0 Hrs	0 %	

## Operating Hours

- A comparison of operating times of machines at multiple locations shows which locations are busier and more profitable.
- Operating hours on site can be accurately recorded, for running time calculations needed for rental machines, etc.

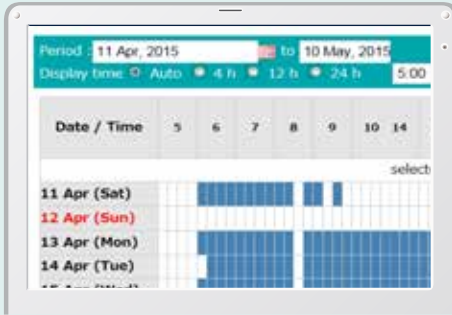

Daily report

## Fuel Consumption Data

Data on fuel consumption and idling times can be used to indicate improvements in fuel consumption.

Work mode	Working Hrs	Total Fuel Consumption
H mode	2:06	24.5 L
S mode	0:00	0.0 L
E mode	169:19	1489.7 L
<b>TOTAL</b>	<b>171:25</b>	<b>1514.2 L</b>

Fuel consumption

## Graph of Work Content

The graph shows how working hours are divided among different operating categories, including digging, idling, traveling and optional operations.

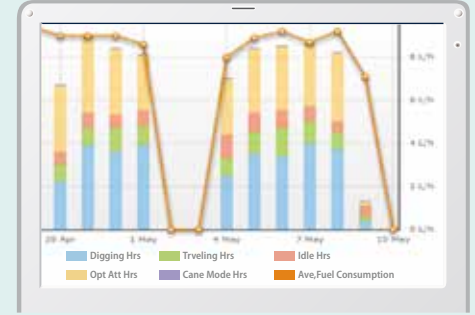

Work status

## Maintenance Data and Warning Alerts

### Machine Maintenance Data

- Provides maintenance status of separate machines operating at multiple sites.
- Maintenance data is also relayed to KOBELCO service personnel, for more efficient planning of periodic servicing.

Model	Serial No.	Hour Meter	Engine Oil
SK135RCL-3/SK140SRL	YH07-09721	734 Hr	434
SK135RCL-3/SK140SRL	YH07-09789	73 Hr	429
SK210LC-9	YQ13-10454	960 Hr	58
SK210LC-9	YQ13-10481	549 Hr	498
SK75SR-	YT08-20374		

Maintenance

### Warning Alerts

This system warns an alert if an anomaly is sensed, preventing damage that could result in machine downtime.

## Alarm Information Can Be Received through E-mail

Alarm information or maintenance notice can be received through E-mail, using a computer or cell phone.



## Daily/Monthly Reports

Operational data downloaded onto a computer helps in formulating daily and monthly reports.

## Security System

### Engine Start Alarm

The system can be set an alarm if the machine is operated outside designated time.

Engine start alarm outside prescribed work time

### Area Alarm

It can be set an alarm if the machine is moved out of its designated area to another location.

Alarm for outside of reset area



## Easy, On-the-Spot Maintenance NEW

There is ample space in the engine compartment for a mechanic to do maintenance work inside. The distance between steps is lower so entry and exit is easier. And the mechanic can work in comfort, without contortions or unnatural body positions. Finally, the hood is lighter and easier to raise and lower.



Generous space for maintenance work



Step/Hand rail



DEF/AdBlue tank



Double-element air cleaner

Positioned where the step opens

## Maintenance Work, Daily Checks, Etc., Can Be Done from Ground Level

The layout allows for easy access from the ground for many daily checks and regular maintenance tasks.



Fuel filter/Pre-filter



Engine oil filter



Left side

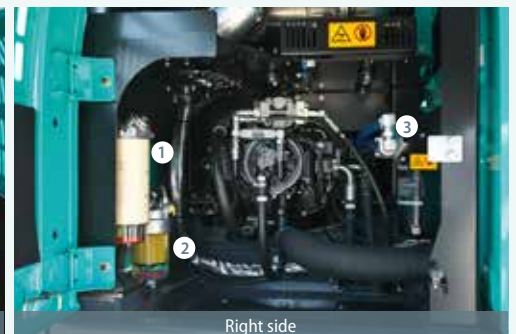

Right side

Laid out for easy access to radiator and cooling system elements

① Refueling pump

① Fuel filter

② Pre-filter

③ Engine oil filter

# Efficient Maintenance Keeps the Machine in Peak Operating Condition



MAINTENANCE			
	INTERVAL	REMAINING TIME	EXCHANGE DAY
ENGINE OIL	500 Hr	495 Hr	--/--/--
FUEL FILTER	500 Hr	495 Hr	--/--/--
HYD. FILTER	1000 Hr	995 Hr	--/--/--
HYD. OIL	5000 Hr	4995 Hr	--/--/--

6.7h

## Machine Information Display Function

Examples of displaying maintenance information

- Displays only the maintenance information that's needed, when it's needed
- Self-diagnostic function provides early-warning detection and display of electrical system malfunctions
- Service-diagnostic function makes it easier to check the status of the machine
- Record function of previous breakdowns including irregular and transient malfunction

## More Efficient Maintenance Inside the Cab



Easy-access fuse box

More finely differentiated fuses make it easier to locate malfunctions.



Air conditioner filters

Internal and external air conditioner filters can be easily removed without tools for cleaning.



DPF reactivation switch

If the monitor warning goes off, the filter should be reactivated manually using a switch.

## Easy Cleaning



Crawler frame

Special crawler frame design is easily cleaned of mud.



Detachable two-piece floor mat

Detachable two-piece floor mat with handles for easy removal. A floor drain is located under floor mat.



Engine oil pan

Engine oil pan equipped with drain valve.

Long-life hydraulic oil:  
**5,000**  
hours

### Long-Interval Maintenance

Long-life hydraulic oil reduces cost and labor.

Replacement cycle:  
**1,000**  
hours

### Highly Durable Super-fine Filter

The high-capacity hydraulic oil filter incorporates glass fiber with superior cleaning power and durability.





## Engine

Model	J05EUN-KSSD
Type	Direct injection, water-cooled, 4-cycle diesel engine with turbocharger, intercooler
No. of cylinders	4
Bore and stroke	112 mm x 130 mm
Displacement	5.123 L
Rated power output	133 kW/2,100 min <sup>-1</sup> (ISO 9249)
	138 kW/2,100 min <sup>-1</sup> (ISO 14396)
Max. torque	636 N-m/1,600 min <sup>-1</sup> (ISO 9249)
	660 N-m/1,600 min <sup>-1</sup> (ISO 14396)



## Hydraulic System

Pump	
Type	Two variable displacement pumps + one gear pump
Max. discharge flow	2 x 245 L/min, 1 x 21 L/min
Relief valve setting	
Boom, arm and bucket	34.3 MPa {350 kgf/cm <sup>2</sup> }
Power Boost	37.8 MPa {385 kgf/cm <sup>2</sup> }
Travel circuit	34.3 MPa {350 kgf/cm <sup>2</sup> }
Swing circuit	29.0 MPa {296 kgf/cm <sup>2</sup> }
Control circuit	5.0 MPa {50 kgf/cm <sup>2</sup> }
Pilot control pump	Gear type
Main control valve	8-spool
Oil cooler	Air cooled type



## Swing System

Swing motor	Axial piston motor
Brake	Hydraulic; locking automatically when the swing control lever is in neutral position
Parking brake	Oil disc brake, hydraulic operated automatically
Swing speed	10.2 min <sup>-1</sup> {rpm}
Tail swing radius	3,100 mm
Min. front swing radius	3,910 mm



## Attachments

Backhoe bucket and combination

Use			Backhoe bucket			
			Normal digging		Light-duty	
Bucket capacity	ISO heaped	m <sup>3</sup>	0.81	1.0	1.2	1.4
	Struck	m <sup>3</sup>	0.59	0.76	0.84	1.0
Opening width	With side cutter	mm	1,060	1,270	1,440	-
	Without side cutter	mm	960	1,120	1,340	1,510
No. of teeth			4	5	5	6
Bucket weight		kg	700	810	850	890
Combination	2.5 m short arm		○	○	◎	△
	2.98 m standard arm		○	◎	△	△
	3.66 m long arm		◎	△	△	×

◎ Standard ○ Recommended △ Loading only × Not recommended



## Travel System

Travel motors	2 x axial-piston, two-step motors
Travel brakes	Hydraulic brake per motor
Parking brakes	Oil disc brake per motor
Travel shoes	51 each side
Travel speed	5.8/3.6 km/h
Drawbar pulling force	245 kN (ISO 7464)
Gradeability	70 % {35°}



## Cab & Control

Cab	
All-weather, sound-suppressed steel cab mounted on the high suspension mounts filled with silicone oil and equipped with a heavy, insulated floor mat.	
Control	
Two hand levers and two foot pedals for travel	
Two hand levers for excavating and swing	
Electric rotary-type engine throttle	
Noise levels	
External	100dB(A)
Operator	67dB(A)



## Boom, Arm & Bucket

Boom cylinders	135 mm x 1,235 mm
Arm cylinder	145 mm x 1,635 mm
Bucket cylinder	125 mm x 1,200 mm



## Refilling Capacities & Lubrications

Fuel tank	403 L
Cooling system	21 L
Engine oil	20.5 L
Travel reduction gear	2 x 5.0 L
Swing reduction gear	5.0 L
Hydraulic oil tank	165 L tank oil level
	273 L hydraulic system
DEF/AdBlue tank	83 L





## Working Ranges

Unit: m

Boom		6.02 m		
Arm		Short	Standard	Long
Range		2.5 m	2.98 m	3.66 m
a-	Max. digging reach	9.89	10.30	10.98
b-	Max. digging reach at ground level	9.72	10.14	10.82
c-	Max. digging depth	6.52	7.00	7.68
d-	Max. digging height	9.65	9.79	10.22
e-	Max. dumping clearance	6.72	6.88	7.28
f-	Min. dumping clearance	3.03	2.55	1.87
g-	Max. vertical wall digging depth	5.82	6.15	6.97
h-	Min. swing radius	3.91	3.91	3.92
i-	Horizontal digging stroke at ground level	4.20	5.26	6.48
j-	Digging depth for 2.4 m (8') flat bottom	6.32	6.82	7.54
Bucket capacity ISO heaped m <sup>3</sup>		1.2	1.0	0.81

## Digging Force (ISO 6015)

Unit: kN

Arm length	Short	Standard	Long
	2.5 m	2.98 m	3.66 m
Bucket digging force	170 187*	170 187*	170 187*
Arm crowding force	142 156*	122 134*	104 —

\*Power Boost engaged

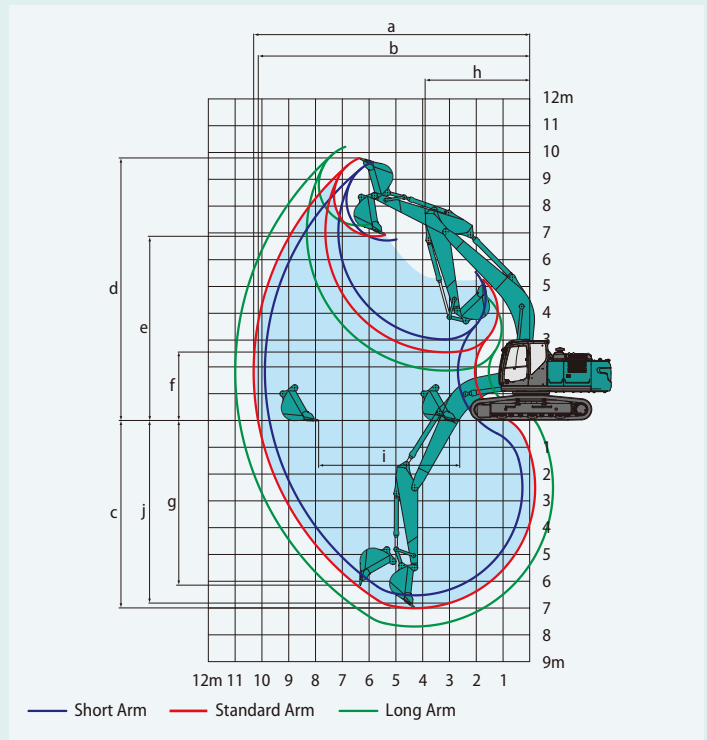

## Dimensions

Arm length		Short	Standard	Long
		2.5 m	2.98 m	3.66 m
A	Overall length	10,270	10,210	10,230
B	Overall height (to top of boom)	3,350	3,220	3,300
C	Overall width of crawler	SK260LC	3,190	
		SK260NLC	2,990	
D	Overall height (to top of cab)	3,090		
E	Ground clearance of rear end*	1,090		
F	Ground clearance*	460		
G	Tail swing radius	3,100		

		Unit: mm	
G'	Distance from center of swing to rear end	3,070	
H	Tumbler distance	SK260LC	3,850
		SK260NLC	3,850
I	Overall length of crawler	SK260LC	4,640
		SK260NLC	4,640
J	Track gauge	SK260LC	2,590
		SK260NLC	2,390
K	Shoe width	600	
L	Overall width of upperstructure	2,980	

\*Without including height of shoe

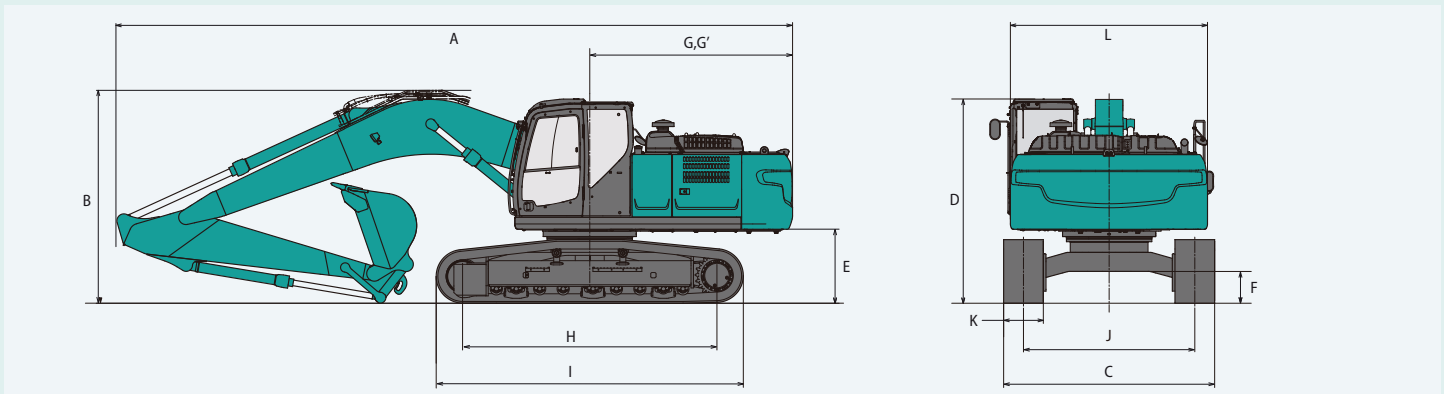

## Operating Weight & Ground Pressure

In standard trim, with standard boom, 2.98 m arm, and 1.0 m<sup>3</sup> ISO heaped bucket

Shaped		Triple grouser shoes (even height)				
Shoe width		mm	600	700	800	900
Overall width of crawler	SK260LC	mm	3,190	3,290	3,390	3,490
	SK260NLC	mm	2,990	3,090	3,190	-
Ground pressure	SK260LC	kPa	52	45	40	36
	SK260NLC	kPa	52	45	40	-
Operating weight	SK260LC	kg	26,200	26,600	26,800	27,200
	SK260NLC	kg	26,100	26,600	26,800	-

# Lifting Capacities

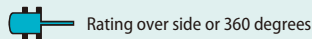
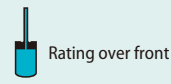
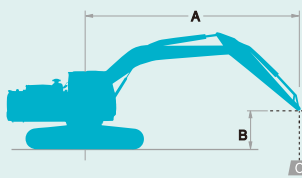

A: Reach from swing centerline to arm top  
 B: Arm top height above/below ground  
 C: Lifting capacities in Kilograms  
 Bucket: Without bucket  
 Relief valve setting: 37.8 MPa (385 kgf/cm<sup>2</sup>)











SK260LC		Boom: 6.02 m Arm: 2.98 m Bucket: without Shoe: 600 mm (Heavy Lift)														
B	A	1.5 m		3.0 m		4.5 m		6.0 m		7.5 m		At Max. Reach		Radius		
		Rating over front	Rating over side or 360 degrees	Rating over front	Rating over side or 360 degrees	Rating over front	Rating over side or 360 degrees	Rating over front	Rating over side or 360 degrees	Rating over front	Rating over side or 360 degrees	Rating over front	Rating over side or 360 degrees			
7.5 m	kg													*4,930	*4,930	6.70 m
6.0 m	kg								*5,800	*5,800	*5,850	5,100		*4,660	*4,660	7.73 m
4.5 m	kg								*6,590	*6,590	*6,110	5,000		*4,620	4,150	8.37 m
3.0 m	kg						*10,070	*10,070	*7,720	6,710	*6,660	4,810		*4,750	3,800	8.71 m
1.5 m	kg						*12,240	9,500	*8,870	6,340	7,010	4,620		*5,060	3,660	8.78 m
G.L.	kg						*13,390	9,120	9,540	6,080	6,850	4,480		*5,620	3,720	8.58 m
-1.5 m	kg	*7,380	*7,380	*11,560	*11,560	*13,590	9,030	9,410	5,970	6,790	4,420			6,090	4,000	8.11 m
-3.0 m	kg	*13,010	*13,010	*18,450	18,270	*12,960	9,120	9,460	6,010					7,130	4,650	7.30 m
-4.5 m	kg			*15,600	*15,600	*11,200	9,400	*8,040	6,260					*8,010	6,240	6.01 m

SK260LC		Boom: 6.02 m Arm: 3.66 m Bucket: without Shoe: 600 mm (Heavy Lift)															
B	A	1.5 m		3.0 m		4.5 m		6.0 m		7.5 m		9.0 m		At Max. Reach		Radius	
		Rating over front	Rating over side or 360 degrees	Rating over front	Rating over side or 360 degrees	Rating over front	Rating over side or 360 degrees	Rating over front	Rating over side or 360 degrees	Rating over front	Rating over side or 360 degrees	Rating over front	Rating over side or 360 degrees	Rating over front	Rating over side or 360 degrees		
7.5 m	kg										*3,870	*3,870			*3,610	*3,610	7.56 m
6.0 m	kg										*5,080	*5,080			*3,420	*3,420	8.49 m
4.5 m	kg								*5,760	*5,760	*5,450	5,050		*3,380	*3,380	9.08 m	
3.0 m	kg								*6,950	6,810	*6,080	4,830		*3,450	3,340	9.39 m	
1.5 m	kg								*11,190	9,680	*8,210	6,380		*3,630	3,230	9.45 m	
G.L.	kg								*9,230	6,050	6,800	4,420		*3,960	3,260	9.27 m	
-1.5 m	kg	*6,500	*6,500	*10,570	*10,570	*13,440	8,910	9,320	5,880	6,680	4,310			*4,520	3,460	8.83 m	
-3.0 m	kg	*10,600	*10,600	*15,510	*15,510	*13,240	8,910	9,290	5,850	6,680	4,310			*5,530	3,920	8.10 m	
-4.5 m	kg	*15,650	*15,650	*17,320	*17,320	*12,080	9,100	*8,940	5,980					*7,250	4,920	6.96 m	
-6.0 m	kg					*9,100	*9,100							*7,540	*7,540	5.17 m	

SK260LC		Boom: 6.02 m Arm: 2.5 m Bucket: without Shoe: 600 mm (Heavy Lift)												
B	A	3.0 m		4.5 m		6.0 m		7.5 m		At Max. Reach		Radius		
		Rating over front	Rating over side or 360 degrees	Rating over front	Rating over side or 360 degrees	Rating over front	Rating over side or 360 degrees	Rating over front	Rating over side or 360 degrees	Rating over front	Rating over side or 360 degrees			
7.5 m	kg											*6,440	*6,440	6.14 m
6.0 m	kg											*6,400	5,260	7.26 m
4.5 m	kg											*6,400	4,450	7.94 m
3.0 m	kg											6,090	4,050	8.29 m
1.5 m	kg											5,910	3,910	8.36 m
G.L.	kg											6,060	3,980	8.16 m
-1.5 m	kg	*11,410	*11,410	*13,430	9,020	9,400	5,960	6,810	4,440	6,620	4,330			7.66 m
-3.0 m	kg	*17,240	*17,240	*12,500	9,170	*9,380	6,060							6.79 m
-4.5 m	kg	*13,930	*13,930	*10,190	9,550							*8,190	7,400	5.38 m

SK260NLC		Boom: 6.02 m Arm: 2.98 m Bucket: without Shoe: 600 mm (Heavy Lift)														
B	A	1.5 m		3.0 m		4.5 m		6.0 m		7.5 m		At Max. Reach		Radius		
		Rating over front	Rating over side or 360 degrees	Rating over front	Rating over side or 360 degrees	Rating over front	Rating over side or 360 degrees	Rating over front	Rating over side or 360 degrees	Rating over front	Rating over side or 360 degrees	Rating over front	Rating over side or 360 degrees			
7.5 m	kg													*4,930	*4,930	6.70 m
6.0 m	kg													*5,800	*5,800	7.73 m
4.5 m	kg													*6,590	6,540	8.37 m
3.0 m	kg													*10,070	9,330	8.71 m
1.5 m	kg													*12,240	8,590	8.78 m
G.L.	kg													*13,390	8,230	8.58 m
-1.5 m	kg	*7,380	*7,380	*11,560	*11,560	*13,590	8,130	9,390	5,430	6,770	4,030			6,070	3,650	8.11 m
-3.0 m	kg	*13,010	*13,010	*18,450	16,070	*12,960	8,220	9,430	5,460					7,110	4,250	7.30 m
-4.5 m	kg			*15,600	*15,600	*11,200	8,500	*8,040	5,710					*8,010	5,690	6.01 m

SK260NLC		Boom: 6.02 m Arm: 3.66 m Bucket: without Shoe: 600 mm (Heavy Lift)															
B	A	1.5 m		3.0 m		4.5 m		6.0 m		7.5 m		9.0 m		At Max. Reach		Radius	
		Rating over front	Rating over side or 360 degrees	Rating over front	Rating over side or 360 degrees	Rating over front	Rating over side or 360 degrees	Rating over front	Rating over side or 360 degrees	Rating over front	Rating over side or 360 degrees	Rating over front	Rating over side or 360 degrees	Rating over front	Rating over side or 360 degrees		
7.5 m	kg														*3,610	*3,610	7.56 m
6.0 m	kg														*5,080	4,790	8.49 m
4.5 m	kg														*5,760	*5,760	9.08 m
3.0 m	kg														*6,950	6,240	9.39 m
1.5 m	kg														*11,190	8,760	9.45 m
G.L.	kg														*9,230	5,500	9.27 m
-1.5 m	kg	*6,500	*6,500	*10,570	*10,570	*13,440	8,020	9,300	5,330	6,660	3,920			*4,520	3,150	8.83 m	
-3.0 m	kg	*10,600	*10,600	*15,510	*15,510	*13,240	8,020	9,260	5,300	6,660	3,930			*5,530	3,570	8.10 m	
-4.5 m	kg	*15,650	*15,650	*17,320	16,060	*12,080	8,200	*8,940	5,430					*7,250	4,490	6.96 m	
-6.0 m	kg					*9,100	8,660							*7,540	7,120	5.17 m	

SK260NLC		Boom: 6.02 m		Arm: 2.5 m		Bucket: without		Shoe: 600 mm (Heavy Lift)				
A	B	3.0 m		4.5 m		6.0 m		7.5 m		At Max. Reach		Radius
												
7.5 m	kg					*6,360	*6,360			*6,440	*6,440	6.14 m
6.0 m	kg					*6,330	*6,330			*6,400	4,840	7.26 m
4.5 m	kg			*8,450	*8,450	*7,060	6,410	*6,510	4,510	*6,400	4,090	7.94 m
3.0 m	kg			*10,850	9,050	*8,140	6,030	*6,960	4,350	6,080	3,710	8.29 m
1.5 m	kg			*12,780	8,390	*9,180	5,690	6,930	4,180	5,890	3,570	8.36 m
G.L.	kg			*13,550	8,140	9,450	5,480	6,800	4,060	6,040	3,640	8.16 m
-1.5 m	kg	*11,410	*11,410	*13,430	8,120	9,380	5,420	6,790	4,050	6,600	3,950	7.66 m
-3.0 m	kg	*17,240	16,240	*12,500	8,270	*9,380	5,510			7,940	4,720	6.79 m
-4.5 m	kg	*13,930	*13,930	*10,190	8,640					*8,190	6,740	5.38 m

**Notes:**

- Do not attempt to lift or hold any load that is greater than these lift capacities at their specified lift point radius and heights. Weight of all accessories must be deducted from the above lift capacities.
- Lift capacities are based on machine standing on level, firm, and uniform ground. User must make allowance for job conditions such as soft or uneven ground, out of level conditions, side loads, sudden stopping of loads, hazardous conditions, experience of personnel, etc.
- Arm top defined as lift point.
- The above lifting capacities are in compliance with ISO 10567. They do not exceed 87% of hydraulic

- lifting capacity or 75% of tipping load. Lifting capacities marked with an asterisk (\*) are limited by hydraulic capacity rather than tipping load.
- Operator should be fully acquainted with the Operator's and Maintenance Instructions before operating this machine. Rules for safe operation of equipment should be adhered to at all times.
- Lift capacities apply to only machine as originally manufactured and normally equipped by KOBELCO CONSTRUCTION MACHINERY CO., LTD.

## STANDARD EQUIPMENT

**ENGINE**

- Engine, HINO J05EUN-KSSD, diesel engine with turbocharger and intercooler
- Automatic engine deceleration
- Auto Idle Stop (AIS)
- Batteries (2 x 12V - 112Ah)
- Starting motor (24V - 5 kW), 60 amp alternator
- Automatic engine shut-down for low engine oil pressure
- Engine oil pan drain cock
- Double element air cleaner
- Refueling pump

**CONTROL**

- Working mode selector (H-mode, S-mode and ECO-mode)
- Power Boost
- Heavy lift

**SWING SYSTEM & TRAVEL SYSTEM**

- Swing rebound prevention system
- Straight propel system
- Two-speed travel with automatic shift down
- Sealed & lubricated track links
- Grease-type track adjusters
- Automatic swing brake

**HYDRAULIC**

- Arm regeneration system
- Auto warm up system
- Aluminum hydraulic oil cooler
- Hydraulic fluid filter clog detector
- Hydraulic pressure adjustment function for N&B piping

**MIRRORS & LIGHTS**

- Three rearview mirrors
- Three front working lights

**CAB & CONTROL**

- Two control levers, pilot-operated
- Horn, electric
- Cab light (interior)
- Luggage tray
- Large cup holder
- Detachable two-piece floor mat
- Headrest
- Handrails
- Intermittent windshield wiper with double-spray washer
- Skylight
- Tinted safety glass
- Pull-up type front window and removable lower front window
- Easy-to-read multi-display color monitor
- Automatic air conditioner
- Emergency escape hammer
- Suspension seat
- Radio, AM/FM stereo with speaker
- TOP guard
- Remote machine monitoring system "KOMEXS"
- Object Handling Kit (boom and arm safety valve + hook)
- Tow eyes

## OPTIONAL EQUIPMENT

- Various optional arms
- Wide range of shoes
- Additional track guide
- Additional hydraulic circuit
- Two cab lights
- Air suspension seat
- Rain visor (may interfere with bucket action)
- Cab guard
- Quick hitch piping
- Travel alarm
- Right side camera

Note: Standard and optional equipment may vary. Consult your KOBELCO dealer for specifics.

Note: This catalog may contain attachments and optional equipment that are not available in your area. And it may contain photographs of machines with specifications that differ from those of machines sold in your areas. Please consult your nearest KOBELCO distributor for those items you require. Specialist equipment is needed to use this machine in demolition work. Before using it please contact your KOBELCO dealer.

Due to our policy of continuous product improvements all designs and specifications are subject to change without advance notice.

Copyright by **KOBELCO CONSTRUCTION MACHINERY CO., LTD.** No part of this catalog may be reproduced in any manner without notice.

---

**Kobelco Construction Machinery Europe B.V.**

Veluwezoom 15  
1327 AE Almere  
The Netherlands  
[www.kobelco-europe.com](http://www.kobelco-europe.com)

Inquiries To: