

KOBELCO

Performance  Design

ED160 *BLADE RUNNER*

- Bucket capacity:
0.24 – 0.7 m³ ISO heaped
- Engine power:
86 kW/2,200 min⁻¹
(ISO14396)
- Operating weight:
16,800 – 18,000 kg



Complies with the EU Stage V
exhaust emission regulation

We Save You Fuel
Achieving a Low-Carbon Society



Performance Design

ED160BR of KOBELCO has realised a completely new value by harmonising PERFORMANCE – greater efficiency and productivity with an increased power and speed and DESIGN – operator-based operability and comfort, refusing to accept any compromises.

In pursuit of unique and matchless machines which are unforgettable once you use them, KOBELCO will continue to rise to meet every challenge.



THE ULTIMATE IN SIMPLE AND ELEGANT DESIGN

Our pursuit of functional beauty and aesthetic sense produced a new interior design.

Jog dial

This jog dial integrates multiple functions to realise simple operations. Even with gloved hands, the operator can set various machine conditions without stress.

LED backlights

The switches and dials have LED backlights – they provide a bright, clear view in the dark and set a luxurious mood.







UNFORGETTABLE COMFORT

① Air suspension seat

A GRAMMER seat is installed as standard equipment, which achieves excellent shock absorption and superior ride comfort.



② Air conditioner blowing from the rear

Air is blown against the operator's waist and the back of their head, offering more comfortable operation.

③ Lever angles allow for comfortable operations

The operator can move the levers horizontally without twisting their wrist, which reduces the fatigue caused by the operations.



New hydraulic control

Our newly upgraded hydraulic control system responds to shorter lever strokes than current models, delivering swifter, more precise movement and improved lever operability.

④ LED door light

The LED interior light automatically turns on when the door is opened or when the ignition is set to OFF. This ensures easy entry and exit at nighttime.

⑤ Parallel wipers secure a wide field of view



KOBELCO

ECO

04:33



SETTING MENU



PICTURE OF CAMERA



CLOCK SETTING



SCREEN BRIGHTNESS



MAINTENANCE



CONSUMPTION



LANGUAGE SELECTION



mode



FLOW RATE 260 L/min

A WIDER VIEW BRINGS A WIDER RANGE OF USE

10-inch colour monitor (the largest in the industry)

The easy-to-operate menu screen facilitates reading of important information. Images from the built-in cameras can be checked on the large screen, which helps secure safety. In addition, each icon has become easy to recognise. A password is required when starting the engine for greater security.



The right camera and rear camera (right side view mode)

The right camera and rear camera (straight view mode)

The right camera and rear camera (right side view mode)

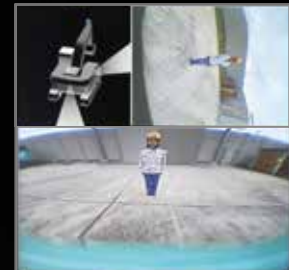

The right camera and rear camera (straight view mode)



The bird's-eye view



The eagle eye view



Right and rear cameras

Images from the right camera and rear camera are displayed together on the large colour monitor. The right camera view can be selected between the straight view mode and right side view mode. In addition, the bird's-eye view mode and eagle eye view mode can also be selected.

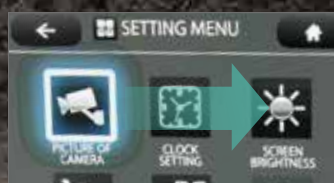

Screen display linked with the jog dial operation

The jog dial can be operated as desired without causing stress. Turn the jog dial to the right or left to select an item and press the dial to confirm the selection.



Power, Angle and Tilt capability (PAT)

The 6-way dozer blade has Power, Angle and Tilt capability (PAT) operated from the cab. With a single control lever, the blade can be angled 25 degrees to the left or right for dispensing earth and materials away for the operator's path. The blade also tilts up on the left and right sides by 445 mm for slope grading, culverts and ditches.

EXPERIENCING A COMPETENT PERFORMANCE

Our high-power engine complies with STAGE V emission regulations

Compared to previous models, the engine output is significantly increased, which thereby shortens the digging cycle time remarkably. It attains high performances without reducing the speed even when heavy a load is applied or when travelling on a slope.

Model: ISUZU 4JJ1XDDV A01

Engine output

Increased by **10 %**

(Compared to the ED160BR-5 model)

Digging cycle time

Shortened by **10 %**

(Compared to the ED160BR-5 model)



Large capacity dozing

ED160 Blade Runner has the power to doze and backfill in all recommended operating positions.

Dimensions:

3,260 mm (width) x **810 mm** (height)

Working ranges:

790 mm (height), **600 mm** (depth)

Drawbar pulling force: **195 kN**

Dozer capacity: **1.6 m³**



Plenty of ground clearance

Excellent ground clearance ensures unhindered travel.





GREATER MULTI-FUNCTION CAPABILITIES





Attachment mode

The flow-rate modes of the bucket, breaker, nibbler, and rotating grapple are set before delivery, which allows you to start operating immediately. Mode settings for other attachments, such as the tilt rotator, can easily be added or changed.



TYPES OF ATTACHMENT MODE

	TYPE	MODE	OBJECTIVE OF MODE
CURRENT MODE		Bucket	Balance in operations such as levelling can be adjusted.
		Breaker	Arm regeneration function considering front attachment weight is provided beforehand.
		Nibbler (crusher)	Change of arm speed due to nibbler (crusher) opening/closing is reduced.

	TYPE	MODE	OBJECTIVE OF MODE
NEWLY ADDED MODE		Rotating grapple	Swing operation on slope while raising attachment/equipment becomes possible. Boom 2-speed systems is controlled by proportional valve.
		Processor	N&B flow rate is set to maximum specifically. Regeneration of arm in operation while using front attachment is changed.
		Thumb bucket	Swing operation while raising attachment/equipment and opening thumb bucket becomes possible.
		Tilt rotator	When combined operation with arm is performed, hydraulic interference is prevented.
		Spare mode for custom setting	This mode should be customized at each field. This is provided for front attachment other than those described above.

Adjustment for hydraulic flow

Divide ratio of hydraulic flow can be adjusted by service factory for custom usage.



NON-STOP OPERATION BY iNDr

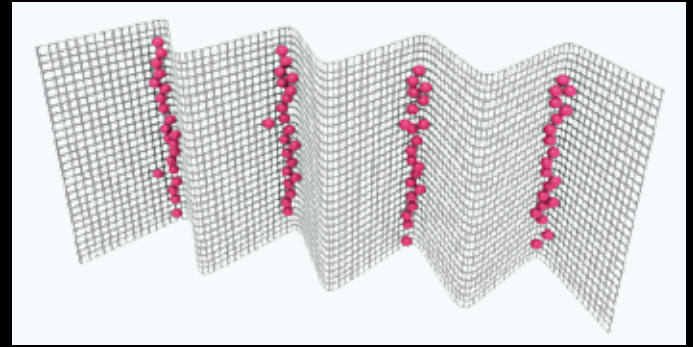
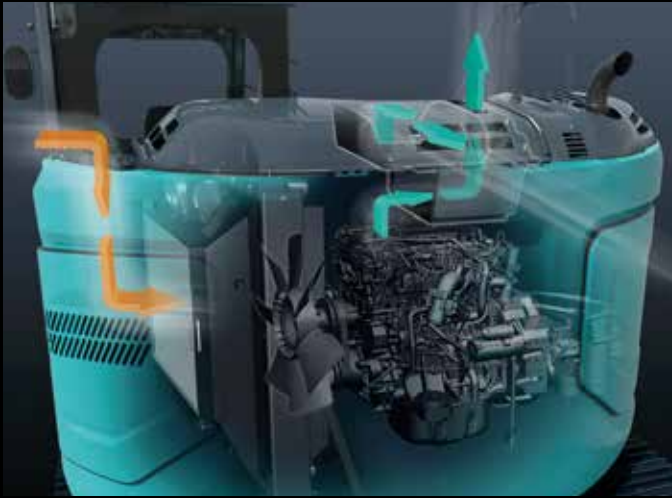

How the filter catches dust

iNDr Filter

A high-density mesh filter blocks dust intruding during air intake. This prevents the cooling device and the air cleaner from clogging with dust and maintains their performances. The ridges of the corrugated filter allow the air to pass through, and the grooves collect the dust, which prevents the filter from clogging.

Total Support for Machines with Network Speed and Accuracy



KOMEXS is a telematics system for receiving machine information. Manage your machines anywhere in the world using the Internet. Location, workload and diagnostic data aid business operations.

Direct Access to Operational Status

Location Data

Accurate location data can be obtained even from sites where communications are difficult.

Fuel Consumption Data

Data on fuel consumption and idling times can be used to indicate improvements in fuel consumption.

Operating Hours

A comparison of operating times of machines at multiple locations shows which locations are busier and more profitable. Operating hours on site can be accurately recorded, for running time calculations needed for rental machines, etc.

Graph of Work Content

The graph shows how working hours are divided among different operating categories, including digging, idling, traveling, and optional operations (N&B).

Maintenance Data and Warning Alerts

Machine Maintenance Data

Provides maintenance status of separate machines operating at multiple sites. Maintenance data is also relayed to KOBELCO service personnel, for more efficient planning of periodic servicing.

Security System

Engine Start Alarm

Sends a notification if the engine is started outside of pre-defined hours.

Area Alarm

Sends a notification if the machine leaves a pre-defined area.

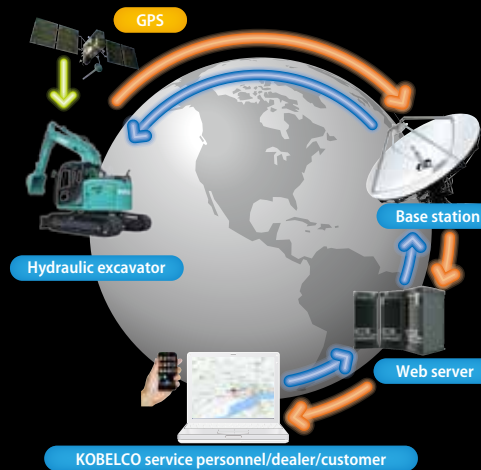

CONVENIENT AND SENSIBLE EQUIPMENT



Engine start password

A password is required when starting the engine for greater security. The initial password must be set at our workshop.

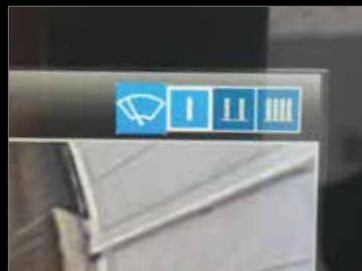

Wiper adjustment function

In addition to the intermittent wiper mode and continuous wiper mode, the one-time wiper mode was added.



Parallel wipers/Roll sun shade



Console mount

The console-integrated seat allows for comfortable operation.



AM/FM Bluetooth® (hands-free) radio



USB port/12 V power outlet



Smartphone holder

You can use the holder with your smartphone connected to the USB port.



Built-in rear camera/right camera

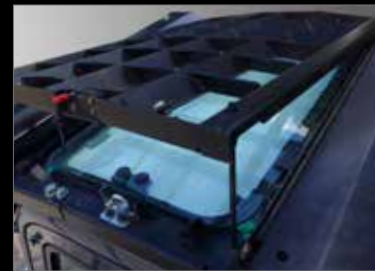

Openable FOPS guard

The openable guard allows for easy maintenance.



Urea tank

Urea filter cap is placed on the step for easy access.

Specifications



Engine

Model	ISUZU MOTORS LIMITED 4JJ1XDDV A01
Type	Four-cycle, liquid-cooled, direct injection diesel, turbo charged complies with EU Stage V exhaust emission regulation
No. of cylinders	4
Bore and stroke	95.4 mm x 104.9 mm
Displacement	2,999 L
Rated power output	78.6 kW/2,200 min ⁻¹ (ISO 9249: with fan) 86 kW/2,200 min ⁻¹ (ISO 14396: without fan)
Max. torque	354 N·m/1,800 min ⁻¹ (ISO 9249: with fan) 375 N·m/1,800 min ⁻¹ (ISO 14396: without fan)



Hydraulic system

Pump	
Type	Two variable displacement piston pumps + one gear pump
Max. discharge flow	2 x 142 L/min 1 x 66 L/min
Relief valve setting	
Boom, arm and bucket	34.3 MPa
Travel circuit	34.3 MPa
Swing circuit	28.0 MPa
Dozer circuit	20.6 MPa
Control circuit	5.0 MPa
Pilot control pump	Gear type
Main control valves	12-spool
Oil cooler	Air cooled type



Swing system

Swing motor	One fixed displacement piston motor
Brake	Hydraulic; locking automatically when the swing control lever is in the neutral position
Parking brake	Wet multiple plate
Swing speed	11.0 min ⁻¹
Tail swing radius	1,490 mm
Swing torque	40.4 kN·m



Attachments

Backhoe bucket and combination

Use			Backhoe bucket						
			Normal digging						
Bucket capacity	ISO heaped	m ³	0.24	0.31	0.38	0.45	0.50	0.57	0.70
	Struck	m ³	0.20	0.23	0.28	0.35	0.38	0.43	0.52
Opening width	With side cutter	mm	590	700	800	915	1,000	1,100	1,275
	Without side cutter	mm	500	640	740	855	940	1,040	1,180
No. of teeth			3	3	4	4	5	5	5
Bucket weight		kg	280	300	340	360	390	410	440
Combination	2.38 m arm		○	○	○	○	⊙	△	△
	2.84 m arm		○	○	⊙	△	×	×	×

⊙ Standard ○ Recommended △ Loading only × Not recommended



Travel system

Travel motors	Variable displacement piston, two-speed motors
Travel brakes	Hydraulic brake
Parking brakes	Wet multiple plate
Travel shoes	40 each side
Travel speed	2.4/4.8 km/h
Drawbar pulling force	195 kN (SAE)
Gradeability	70% {35°}



Cab & control

Cab	
All-weather, sound-suppressed steel cab mounted on the silicon-sealed viscous mounts and equipped with a heavy, insulated floor mat	
Control	
Two hand levers and two foot pedals for travel	
Two hand levers for excavating and swing	
Electric rotary-type engine throttle	
Noise levels	
External	99 dB(A)
Operator	74 dB(A)



Boom, arm & bucket

Boom cylinders	100 mm x 1,092 mm
Arm cylinder	115 mm x 1,116 mm
Bucket cylinder	100 mm x 903 mm



Dozer blade

Dozer cylinder	125 mm x 202 mm
Dimensions	3,260 mm (width) x 815 mm (height)
Working ranges	790 mm (up) x 600 mm (down)
Max. tilt height	445 mm
Angle	25 degrees



Refilling capacities & lubrications

Fuel tank	186 L
Cooling system	17 L
Engine oil	17 L
Travel reduction gear	2 x 50 L
Swing reduction gear	1.65 L
Hydraulic oil tank	89.9 L tank oil level
	190 L hydraulic system
DEF/Urea tank	20.7 L

Working ranges

Unit: m

Boom	4.68 m		
Range	Arm	2.38 m	2.84 m
a- Max. digging reach		8.37	8.81
b- Max. digging reach at ground level		8.17	8.62
c- Max. digging depth		5.36	5.79
d- Max. digging height		9.34	9.73
e- Max. dumping clearance		6.91	7.30
f- Min. dumping clearance		2.78	2.44
g- Max. vertical wall digging depth		4.34	4.77
h- Min. swing radius		2.13	2.52
i- Horizontal digging stroke at ground level		4.22	4.71
j- Digging depth for 2.4 m (8') flat bottom		5.13	5.60
Bucket capacity ISO heaped m ³		0.50	0.38

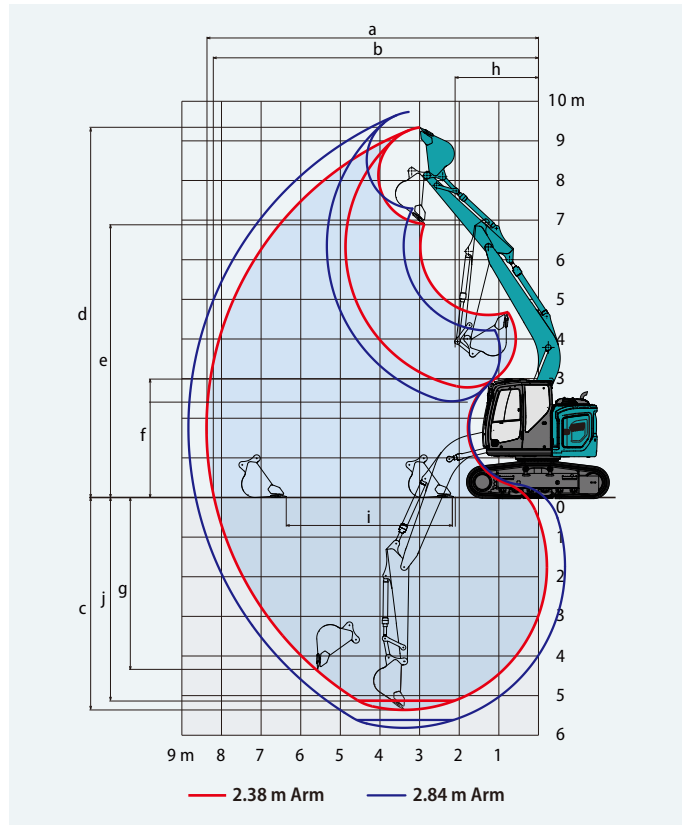

Digging force (ISO 6015)

Unit: kN

Arm length	2.38 m	2.84 m
Bucket digging force	105.4	
Arm crowding force	64.0	58.0

Dimensions

Unit: mm

Arm length	2.38 m	2.84 m		
A Overall length	8,550	8,640	G' Distance from centre of swing to rear end {additional counterweight}	1,490 {1,600**/1,670***}
B Overall height (to top of boom)	2,820	3,180	H Tumbler distance	2,800
C Overall width of crawler (600 mm shoe)	2,590		I Overall length of crawler	3,600
D Overall height (to top of cab)	3,020		J Track gauge	1,990
E Ground clearance of rear end*	1,030		K Shoe width	600
F Ground clearance*	455		L Overall width of upperstructure	2,480
G Tail swing radius {additional counterweight}	1,490 {1,610**/1,670***}		M Overall width (blade wings extended)	3,260
			N Folding blade width	2,460

*Without including height of shoe lug **580 kg counterweight ***1,000 kg counterweight

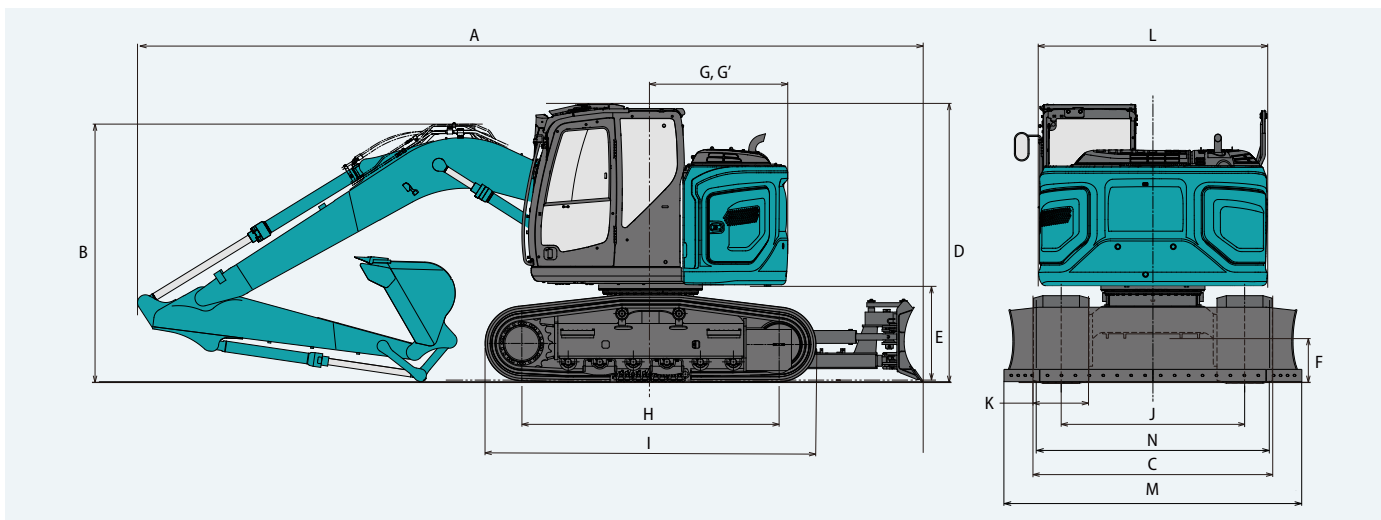

Operating weight & ground pressure

Boom: 4.68 m Arm: 2.38 m Bucket: 0.5 m³ ISO heaped bucket Dozer: with

Shoes (mm)	Curved triple grouser shoes					
	500	600	500	600	500	600
Counterweight	standard		+ 580 kg		+ 1000 kg	
Ground pressure (kPa)	53.5	45.2	55.4	46.7	56.7	47.8
Operating weight (kg)	16,800	17,000	17,400	17,600	17,800	18,000

Lift capacities

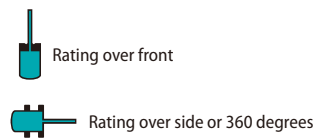
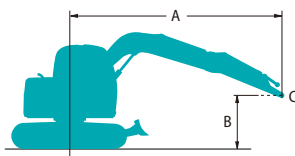

A - Reach from swing centreline to arm top
 B - Arm top height above/below ground
 C - Lift point
 Relief valve setting: 34.3 MPa

ED160BR		Arm: 2.38 m		Counterweight: 1,720 kg		Shoe: 600 mm		Dozer: blade up				
		1.5 m		3.0 m		4.5 m		6.0 m		At max. reach		Radius
B	A											
7.5 m	kg									*2,180	*2,180	4.06 m
6.0 m	kg					*3,390	*3,390			*1,780	*1,780	5.68 m
4.5 m	kg			*4,470	*4,470	*3,730	*3,640	2,760	2,280	*1,660	*1,660	6.57 m
3.0 m	kg			*6,840	6,280	4,210	3,380	2,660	2,180	*1,670	*1,670	7.03 m
1.5 m	kg			*5,040	*5,040	3,910	3,110	2,530	2,070	*1,780	1,590	7.13 m
G.L.	kg			*6,320	5,350	3,730	2,950	2,440	1,980	2,000	1,640	6.90 m
-1.5 m	kg	*5,680	*5,680	7,390	5,380	3,690	2,910	2,430	1,970	2,270	1,850	6.30 m
-3.0 m	kg	*9,370	*9,370	*6,180	5,540	3,780	2,990			3,070	2,470	5.20 m

ED160BR		Arm: 2.38 m		Counterweight: 1,720 + 580 kg		Shoe: 600 mm		Dozer: blade up				
		1.5 m		3.0 m		4.5 m		6.0 m		At max. reach		Radius
B	A											
7.5 m	kg									*2,180	*2,180	4.06 m
6.0 m	kg					*3,390	*3,390			*1,780	*1,780	5.68 m
4.5 m	kg			*4,470	*4,470	*3,730	*3,730	3,030	2,500	*1,660	*1,660	6.57 m
3.0 m	kg			*6,840	*6,840	*4,520	3,710	2,930	2,410	*1,670	*1,670	7.03 m
1.5 m	kg			*5,040	*5,040	4,230	3,440	2,810	2,290	*1,780	*1,780	7.13 m
G.L.	kg			*6,320	5,940	4,140	3,280	2,720	2,210	*2,010	1,830	6.90 m
-1.5 m	kg	*5,680	*5,680	*7,910	5,970	4,090	3,240	2,700	2,200	*2,510	2,070	6.30 m
-3.0 m	kg	*9,370	*9,370	*6,180	6,130	4,190	3,320			*3,340	2,750	5.20 m

ED160BR		Arm: 2.38 m		Counterweight: 1,720 + 1,000 kg		Shoe: 600 mm		Dozer: blade up				
		1.5 m		3.0 m		4.5 m		6.0 m		At max. reach		Radius
B	A											
7.5 m	kg									*2,180	*2,180	4.06 m
6.0 m	kg					*3,390	*3,390			*1,780	*1,780	5.68 m
4.5 m	kg			*4,470	*4,470	*3,730	*3,730	3,230	2,670	*1,660	*1,660	6.57 m
3.0 m	kg			*6,840	*6,840	*4,520	3,950	3,130	2,580	*1,670	*1,670	7.03 m
1.5 m	kg			*5,040	*5,040	4,610	3,680	3,010	2,460	*1,780	*1,780	7.13 m
G.L.	kg			*6,320	*6,320	4,430	3,520	2,920	2,380	*2,010	1,970	6.90 m
-1.5 m	kg	*5,680	*5,680	*7,910	6,390	4,390	3,480	2,900	2,370	*2,510	2,220	6.30 m
-3.0 m	kg	*9,370	*9,370	*6,180	*6,180	*4,250	3,560			*3,340	2,940	5.20 m

Note:

- Do not attempt to lift or hold any load that is greater than these lifting capacities at their specified lift point radius and heights. Weight of all accessories must be deducted from the above lifting capacities.
- Lifting capacities are based on machine standing on level, firm, and uniform ground. User must make allowance for job conditions such as soft or uneven ground, out of level conditions, side loads, sudden stopping of loads, hazardous conditions, experience of personnel, etc.
- Arm top defined as lift point.
- The above lift capacities are in compliance with ISO 10567. They do not exceed 87% of hydraulic lift capacity or 75% of tipping load. Lift capacities marked with an asterisk (*) are limited by hydraulic capacity rather than tipping load.
- Operator should be fully acquainted with the Operator's and Maintenance Instructions before operating this machine. Rules for safe operation of equipment should be adhered to at all times.
- Lifting capacities apply to only machine as originally manufactured and normally equipped by KOBELCO CONSTRUCTION MACHINERY CO., LTD.

STANDARD EQUIPMENT

ENGINE

- Engine, ISUZU 4JJ1XDDV A01, diesel engine with turbocharger and intercooler (Stage V-compliant engine)
- Auto Idle Stop
- Automatic engine deceleration
- Batteries (2 x 12 V - 88 Ah)
- Starting motor (24 V - 4 kW), 50 amp alternator
- Engine oil pan drain cock
- Double element air cleaner
- Refueling pump

CONTROL

- Working mode selector (H-mode, S-mode and ECO-mode)
- Extra N&B piping (proportional hand controlled)
- Boom, arm safety valves and overload alarm

SWING SYSTEM & TRAVEL SYSTEM

- Swing rebound prevention system
- Straight propel system
- Two-speed travel with automatic shift down
- Sealed & lubricated track links
- 600 mm curved shoe
- Grease-type track adjusters
- Automatic swing brake
- Tilt angle dozer blade
- Lower Frame Guard

MIRRORS, LIGHTS and CAMERAS

- Rear view mirror, rear view camera, left side view camera and right side view camera
- Eagle eye view
- Three front working lights (two for boom and one for right storage box)

CAB & CONTROL

- Two control levers, pilot-operated
- Horn, electric
- Integrated left-right slide-type control box
- Cab light (interior)
- Coat hook
- Large cup holder
- Detachable two-piece floor mat
- Retractable seatbelt
- Headrest
- Handrails
- Intermittent windshield wiper with double-spray washer
- Skylight
- Openable top guard (ISO 10262: 1998)
- Tinted safety glass
- Pull-up type front window and removable lower window
- Easy-to-read 10-inch LCD SCREEN multi-display monitor
- Emergency escape hammer
- EU radio (AUX & USB & Bluetooth)
- 12 V converter
- GRAMMER air suspension seat with heater
- Remote machine monitoring system "KOMEXS"
- USB port
- Automatic air conditioner
- Air conditioning system
The air conditioning system on this machine contains fluorinated greenhouse gas HFC-134a (GWP 1430).
Quantity of gas 0.8 kg (CO₂ equivalent 1.2 t)

OPTIONAL EQUIPMENT

- Various optional arms
- Wide range of shoes
- Front-guard protective structure (may interfere with bucket action)
- LED cab additional lights
- Rain visor (may interfere with bucket action)

- Travel alarm
- Add-on counterweight (+ 580/1,000 kg)
- OHK hook
- Roll sun shade
- Quick hitch piping

Note: Standard and optional equipment may vary. Consult your KOBELCO dealer for specifics.

Note: This catalogue may contain attachments and optional equipment that are not available in your area. And it may contain photographs of machines with specifications that differ from those of machines sold in your areas. Please consult your nearest KOBELCO distributor for those items you require. Due to our policy of continuous product improvements all designs and specifications are subject to change without advance notice.
Copyright by **KOBELCO CONSTRUCTION MACHINERY CO., LTD.** No part of this catalogue may be reproduced in any manner without notice.

KOBELCO CONSTRUCTION MACHINERY EUROPE B.V.

Veluwezoom 15
1327 AE Almere
The Netherlands
www.kobelco-europe.com

Enquiries To: